

Date	Changes	REV
05.02.2017	Original	1.0

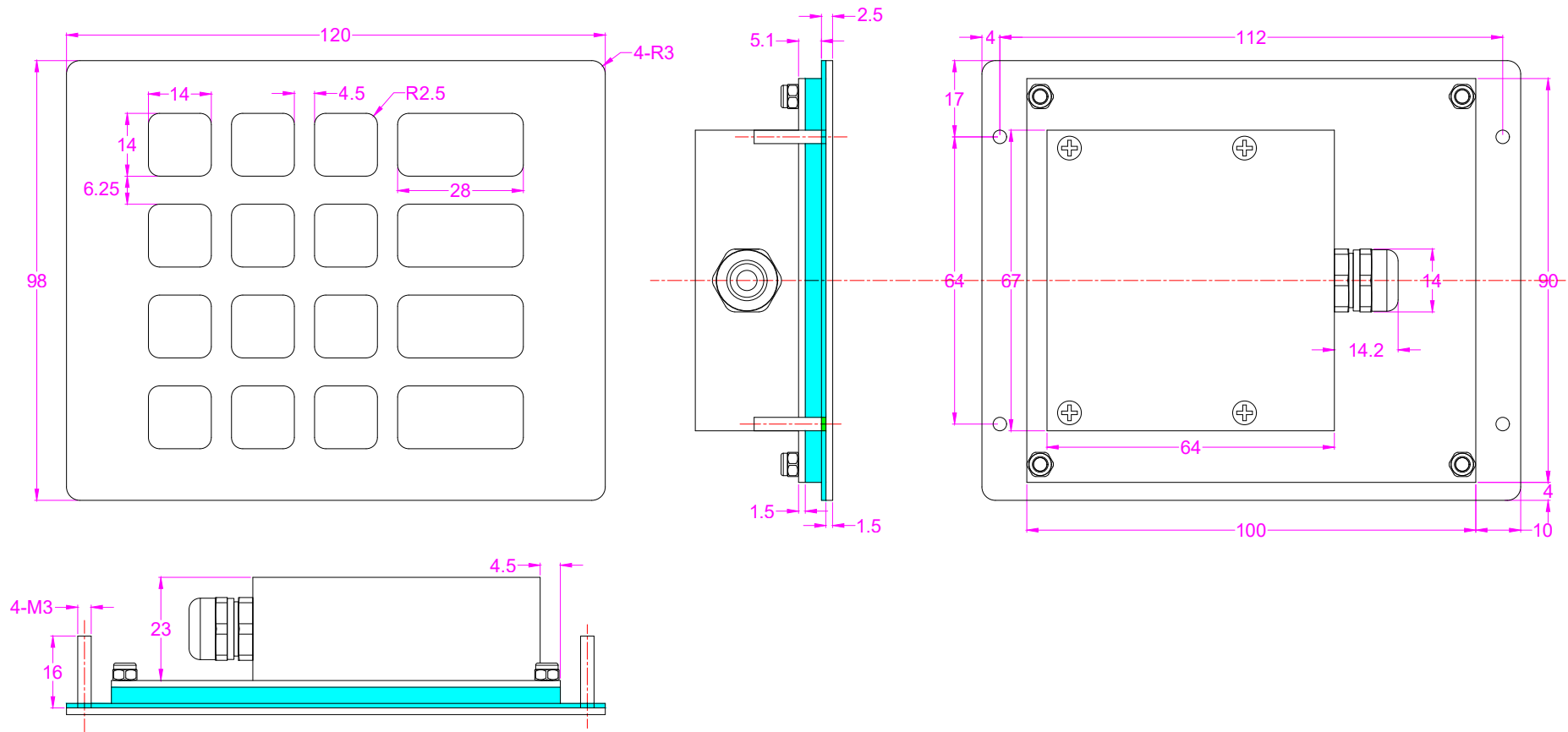

KEY TECHNOLOGY(CHINA)LIMITED

深圳市键特电子有限公司



www.key-tek.cn www.ikb-mkb.com

Part Name	K-TEK-B120KP-DWP			Project Name				
Part No.				Project No.				
Material				Scale	1:1	Unit	mm	
Date	05.02.2017	Version	1.0	Tolerance	IT12	Sheet	1 of 1	
Designed	Chen Xiaobing	Audited		Tony Deng		Approved		